

Wind Energy

A GUIDE FOR SMALL TO
MEDIUM SIZED ENTERPRISES



European Commission



ENERGIE

WIND ENERGY

a guide for small to medium sized enterprises

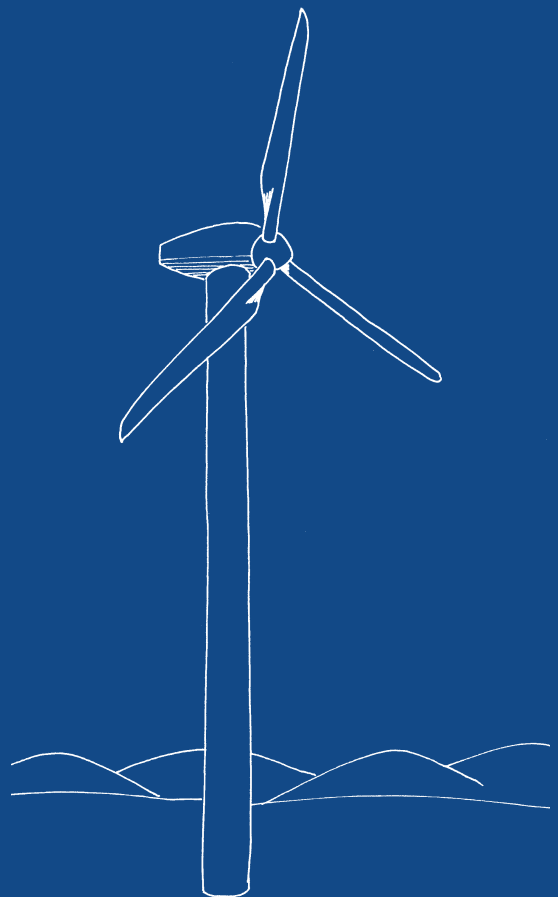

Forward

In September 2000 delegates from a number of European countries gathered in Copenhagen to discuss a way of promoting the use of small wind turbines or small clusters to individuals and **SME's** such as farmers. **ETSU (UK)** in partnership with the Western Regional Energy Agency and Network (**WREAN**) (**UK**) are leading this **OPET** (Organisations for the Promotion of Energy Technologies) action.

This handbook highlights renewable energy as an option for individuals and SME's showing that wind power can present business opportunities. Perhaps one such opportunity would be to sell on electricity to the local electricity supply grid. Another option would be to produce power to use oneself.

As time goes on there is a greater need for farm diversification. The information within this handbook is intended to encourage farmers to produce greener energy with the use of wind turbines, which may lead to an alternative to their farm income. Farmers could use wind turbines to produce power to use for their own electricity needs or they could undertake a larger development to supply power to the electricity grid.

This partnership between European countries has allowed one country to learn from another that may be more advanced in providing wind energy. Therefore, this handbook will disseminate information of value to many European countries and act as a reference guide to many European case studies, which have been selected by the partners contributing to the handbook.

This handbook should be easily understood and act as an introduction to the use of wind energy for any individual or SME such as a farm.

European Commission 2001

Contents

Introduction	4
Why Use Wind Energy?	4
Aims and Objectives of this Handbook	5
Structure of this Handbook	5

Chapter 1: Wind Resources

1.1 Introduction	7
1.2 The Wind as a Source of Energy	7
1.3 Wind as an Energy Source in the UK	8

Chapter 2: How a Wind Turbine Works

2.1 Introduction	10
2.2 Wind Turbine Components	10
2.3 Wind Turbine Size Ranges	10

Chapter 3: Types of Wind Application

3.1 Introduction	12
3.2 Stand Alone Systems	12
3.3 Hybrid Systems	13
3.3.1 Wind-Diesel System	13
<i>Case Study - Holwell Farm</i>	
<i>Russian Example</i>	
3.3.2 Wind-Solar PV System	15
3.4 Grid Connected Applications	15
3.4.1 Connecting to the Grid Network	16
3.4.2 Cost of Grid Connection	16

Chapter 4: Development of a Wind Energy Project

4.1 Introduction	18
EWEA Development Chart for Wind Energy	19

Chapter 5: Financing a Wind Energy Project

5.1 Introduction - Project Feasibility	21
5.2 Costing a Wind Project	21
5.2.1 The Initial Capital Investment	21
5.2.2 Recurring Annual Costs	22
5.3 Financing a Wind Development	22
5.3.1 Typical Information Required by a Bank to Support a Loan Application	23

Chapter 6: Planning

6.1	Introduction	25
6.2	Obtaining Planning Permission	25
6.3	Siting	25
6.4	Environmental Considerations	25

Chapter 7: Public Acceptability

7.1	Introduction	30
7.2	Involving Communities	30
7.3	Benefits of Wind Energy to the Public	30
7.4	Wind Turbine Co-operatives and Other Types of Ownership	31

Chapter 8: Wind Development Time Scenario, Maintenance and Health and Safety

8.1	Time Scenario	33
8.1.1	Off Grid Application Case Study	33
8.1.2	Grid Connected Application Case Study	33
8.2	Maintenance	33
8.2.1	Maintenance for Off-Grid Small Scale Wind Projects	34
8.2.2	Maintenance for Large Scale Wind Developments	34
8.3	Health and Safety	34
8.3.1	Turbine Safety Issues	34
8.3.2	Maintenance procedures	34
8.3.3	Publications	35

Chapter 9: Frequently Asked Questions	37
---------------------------------------	----

Chapter 10: Conclusions	39
-------------------------	----

Chapter 11: Bibliography	41
--------------------------	----

Chapter 12: Appendices

Appendix 1	Glossary	43
Appendix 2	History of Wind Power	45
Appendix 3	Units of Measurement	46
Appendix 4	Abbreviations	47
Appendix 5	Case Studies from Various European Countries	
	<i>Off Grid Applications</i>	
	1. Kaunas, Lithuania	48
	2. Dartmoor, England	48
	3. Castalla, Spain	49
	4. Castalla, Spain	50
	<i>Grid Connected Applications</i>	
	1. Cisowo, Poland	51
	2. Cornwall, England	52
	3. Ross-Shire, Scotland	52
	4. Cambridgeshire, England	52
Appendix 6	Contact Names and Addresses	53
Appendix 7	Publication recommended by the European Commission	55

Introduction

There is an increasing interest in the use of energy sources due to the concern caused by global warming and the greenhouse gas effect. Using fossil fuels pollutes our environment, for example, carbon dioxide emissions add to global warming and oxides of sulphur and nitrogen cause acid rain. People now realise reserves of fossil fuels are rapidly depleting. Taking all of this into consideration the opportunities available to use renewable resources are becoming more and more attractive.

Renewable energy is available to us in many forms such as: wind energy, hydro power, solar energy, tidal and wave energy, biomass, and energy from waste. It is attractive because it produces little or no net polluting emissions. The resources available to be harnessed by renewable energy technologies are constantly renewed and will never run out.

The use of wind energy around the world has increased dramatically over the last decade or so. Currently there are more than 20,000 wind turbines installed world-wide that provide electricity generation. Advances in technology means that this form of energy can now be harnessed reliably and cost effectively. The existing technology offers a range of power ratings from a few kilowatts to several megawatts. Hence the technology now provides the opportunity for people to use wind energy for a variety of applications from small scale, e.g. charging a battery or providing power to a dwelling, to large scale developments that supply electricity to the electricity network.

Why Use Wind Energy?

A lot of people consider climate change as the single greatest threat to our environment. If we continue polluting our atmosphere with green house gas emissions this could result in massive adverse changes such as a dramatic change in weather patterns. This may result in death and the destruction of habitats, a rise in sea levels and the area of desert could increase in size.

In December 1997 representatives from over 160 nations gathered in Kyoto, Japan, for the third Conference of Parties of the United Nations Framework Convention on Climate Change. There were 10 days of intensive negotiations at the conference, after which a draft agreement was reached on reducing the emissions of gases, which have been blamed for causing global warming.

The UK agreed to set targets to cut greenhouse gas emissions under the Kyoto Protocol. It intends to have cut greenhouse gas emissions by 12.5% below 1990 levels by 2008-2010. Further cuts that are needed to avoid perhaps the worst effects of climate change include a government goal to cut carbon dioxide emissions by 20% by the year 2010. With these cuts in mind, the switch to other forms of energy supply must begin now. This means that we can expect a large increase in the use of renewable energy in the near future.

Currently, renewable energy sources provide nearly 5.4 % of the European Union's primary energy needs and have the resources to provide considerably more. The British Wind Energy Association (BWEA) predicts that the UK will have 2005MW (**megawatts**) of wind energy operating by the end of 2005. The turbines would produce almost 1.6% of the total electricity supply of the UK, meeting the power demands of 1.25 million households.

Aims and Objectives of this Handbook

- To provide a layman's guide on the factors and considerations for the use of wind energy.
- To encourage the uptake of single installations of both small and large-scale wind turbines, by individuals and small to medium size enterprises (**SMEs**) such as farmers, and other businesses, for grid-connected and off-grid applications.
- To review the work already done on wind energy and present project case studies on wind energy developments specific to individual countries.
- To be available as a source of reference - with translations into the languages all of the countries involved in this project.

Structure of this Handbook

This handbook takes the reader step by step through the process of examining wind technology as a potential energy source.

It provides an explanation of what wind power actually is and how it can be harnessed using modern wind turbines. A brief description is provided on the options for stand alone systems and grid-connected turbines. The handbook overviews the complete wind energy development process. This includes an overview of the necessary phases in the development process and includes guidance on how to seek planning permission and outlines the environmental considerations for sites.

The handbook also considers the options for ownership by individuals, small businesses and community groups.

Case studies of the use of wind turbines are given as examples so that the basic technical knowledge given in the handbook can be related to real life. A brief history of wind usage and current developments is also discussed. At the back of the handbook there is a chapter which answers frequently asked questions about wind energy. The appendices contain extra information such as units of measurement, abbreviations, further case studies etc.

The full contents listing is shown at the front of the handbook.

CHAPTER 1

Wind Resources

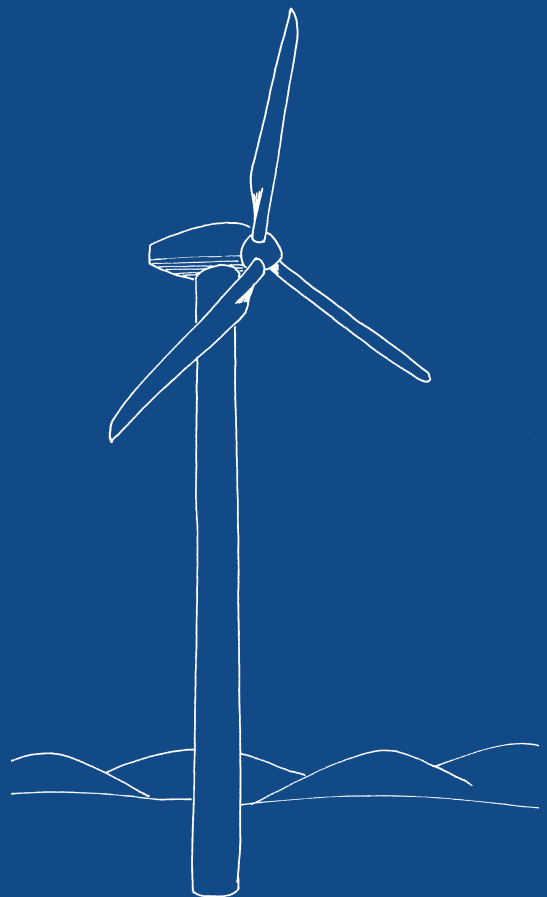

1.1 Introduction

Wind power can be thought of as another form of solar energy because the sun is the driving force behind the world's weather systems.

“Wind power has been harnessed by man for over 2,000 years and is one of the most promising renewable energy sources for electricity generation”.¹

Wind is an intermittent and very complex resource. It is strongly influenced by geographic effects such as the local terrain and ground cover such as trees and buildings. Wind speeds generally increase with the height above sea level and the height above ground. The power available in the wind increases with the cube of the wind speed. A doubling of the wind speed gives an eight times increase in the power available from the wind. Hence an average wind speed of 5 meters per second (m/s) contains nearly twice as much power as wind at 4m/s.

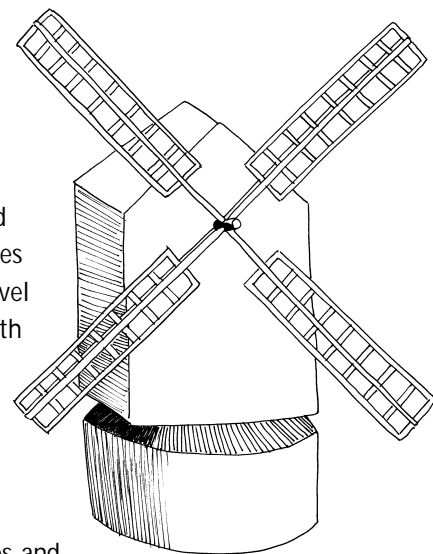

Wind energy developments should be sited away from obstacles such as trees and man made structures as such obstacles generally reduce the wind speed, cause turbulence and so restrict energy capture.

1.2 The Wind as a Source of Energy

Modern wind turbines are tough, durable machines and they are extremely efficient at converting the energy in the wind into electricity. A question someone who is considering using the wind as an energy source needs to ask is “Can I use wind turbines in the area in which I live?”

There are a number of factors to take into consideration when proposing to site wind turbines in a specific area - these factors are discussed in the forthcoming section. However, the first question to be answered is “Does the site have sufficiently high wind speeds for a wind turbine development to be viable?”

To ascertain whether a country/general area has a strong enough wind resource for wind turbine developments reference should be made to a wind atlas.

The wind that blows across Western Europe is strongest in the coastal and upland areas, and particularly strong in the United Kingdom. Further information can be obtained from the European Wind Energy Association (EWEA), see appendix 6 for contact details. If there is not a strong enough wind resource in the area under consideration an alternative more suitable form of renewable energy should be investigated.

A wind energy database is available in the UK that allows the wind speed to be determined anywhere in the country for a given map reference. It is possible to determine the wind speed at several heights within a 1km x 1km grid surrounding the map reference of interest. This information is available from a database of wind speeds and can be accessed by contacting the British Wind Energy Association (BWEA).

Note: Both the EWEA and BWEA are trade associations for the wind energy industry.

1.3 Wind as an Energy Source in the United Kingdom

Due to the UK's geographic position in the Northern Hemisphere the British Isles benefits from being in the path of low pressure weather systems. This results in the UK having one of the best wind resources in Europe.

The European Wind Atlas² shows that a large area of the UK (around 37,500 sq. km) has an annual average wind speed of greater than 7.5 meters per second. Such windy areas are good sites for wind energy development.

Wind turbine developments in offshore coastal areas could increase the potential to generate wind energy even further. Examples of such developments can be seen in the UK, Denmark, Holland and Sweden. This handbook does not go into detail about offshore wind turbines because they are usually on a very large scale. Further information on offshore wind turbines can be found in the "Assessment of Offshore Wind Energy Resources"⁴ details of which are given in the bibliography in the back of this handbook.

CHAPTER 2

How a Wind Turbine Works

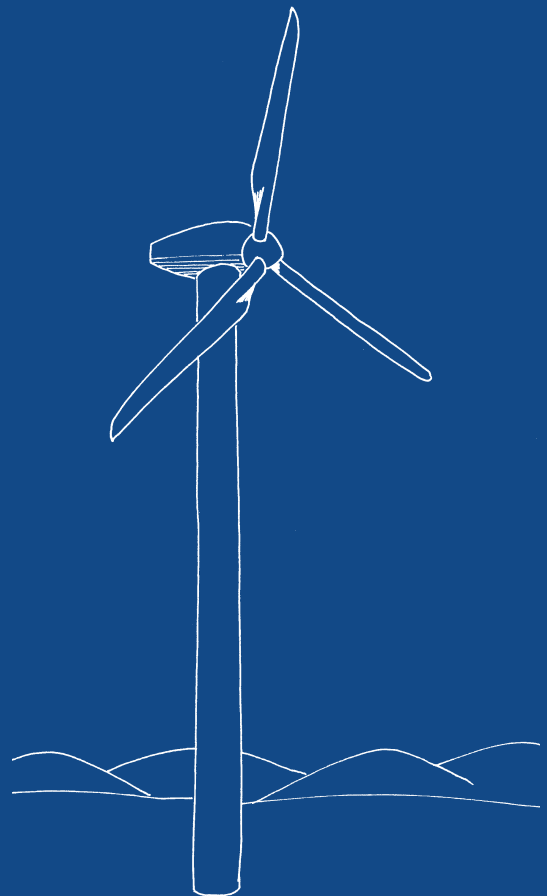

2.1 Introduction

Modern wind turbines are machines that convert mechanical power from a rotating horizontal shaft (like a traditional wind mill) to electrical power. Typically the shaft drives a gearbox which in turn drives an electrical generator. There are many different turbine designs. The most common is the up-wind 3 bladed 'stall controlled' constant speed machines. Typically, turbines range in capacity from a few kilowatts (kW) to 1.3 MW.

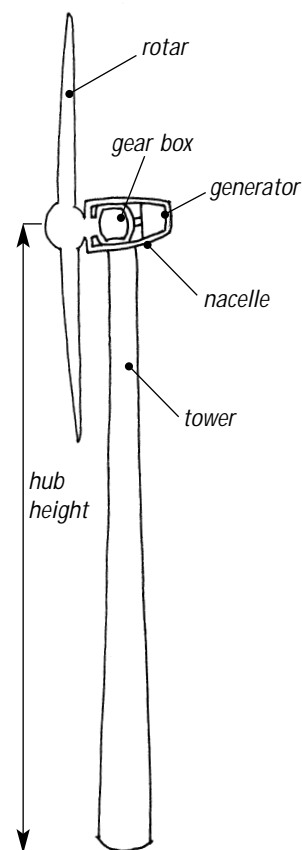

2.2 Wind Turbine Components

The size of the **rotor** ranges from a few meters to up to 65 meters in diameter. The blades rotate at 15 to 50 rpm at a constant speed although some machines are now variable speed. **Towers** range in height from 10 to 75 meters. They are generally cylindrical structures, although lattice structures are used in some countries. Most turbines have a **gearbox** so that the generator can run at a sufficiently high speed.

To prevent damage to the wind turbine machinery when there are gales, almost all turbines are designed to stop automatically. So that the maintenance to the machines can be carried out, they are fitted with one or possibly more braking systems. As well as being able to stop, the turbine must also be able to **yaw** so that it can retain its alignment with the wind.

2.3 Wind Turbine Size Range

The size of turbine to be selected will depend on the proposed usage or application of the wind system. For example if the wind development is to be grid connected it is probable that the turbines will have a capacity in the range of 50-500kW or perhaps higher- some developments now use turbines with capacities of 1.3 MW or greater.

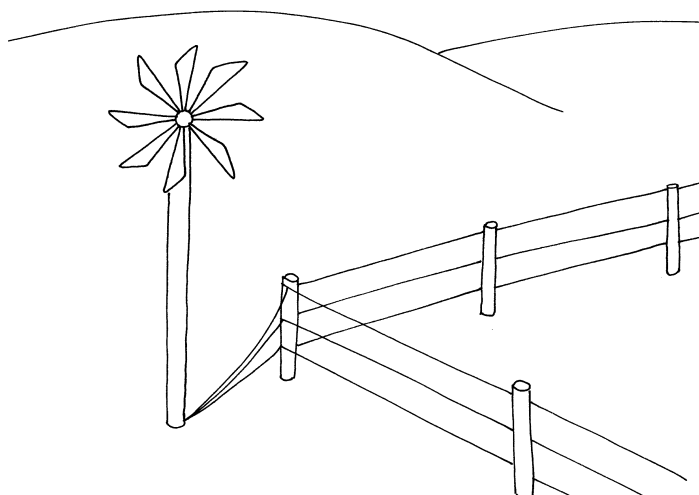

Generally smaller turbines are used for off-grid applications. For example a wind turbine for a single dwelling may typically range from a few kW up to around 10kW, depending on the electricity requirements. This type of system would typically have battery storage and may also have a diesel generator which would act as standby during calm wind periods. Business premises or remote communities could make use of similar systems on a larger scale. In remote rural areas smaller turbines of 1kW or so could be used for battery charging and provide power for small applications. One example of a use for a small wind turbine is to supply energy to an electric fence.

CHAPTER 3

Types of Wind Applications

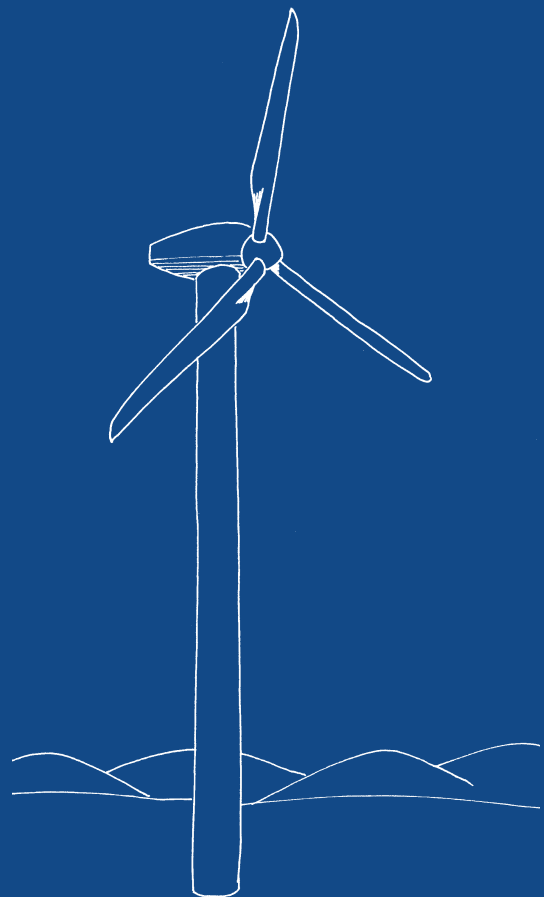

3.1 Introduction

Wind turbines can be either connected to the electricity grid so that the power they produce is distributed to the local electricity network or they can be stand alone (off- grid), where the power they produce is used locally.

A number of examples of such projects are presented in appendix 5.

Although the handbook is mainly concerned with off-grid systems grid connected systems are referred to so that a balanced overview of the use of wind turbines is presented. The types of applications available are considered in more detail below:

3.2 Stand Alone Systems

A Stand Alone wind turbine is one that runs independently of any external mains power network. However such systems may run in conjunction with other generators as part of an integrated power system. Typically, such systems could be used for powering a domestic dwelling/farm buildings or SME's premises etc. These systems will usually generate d.c. output suitable for battery charging. An inverter can be incorporated in the system to convert the energy stored in the batteries into a 240 volt a.c. power supply. Larger community scale systems, which may serve a number of houses, will usually generate alternating current at mains supply voltage. In some remote regions such systems may be cost effective when compared against the cost of an electric grid extension.

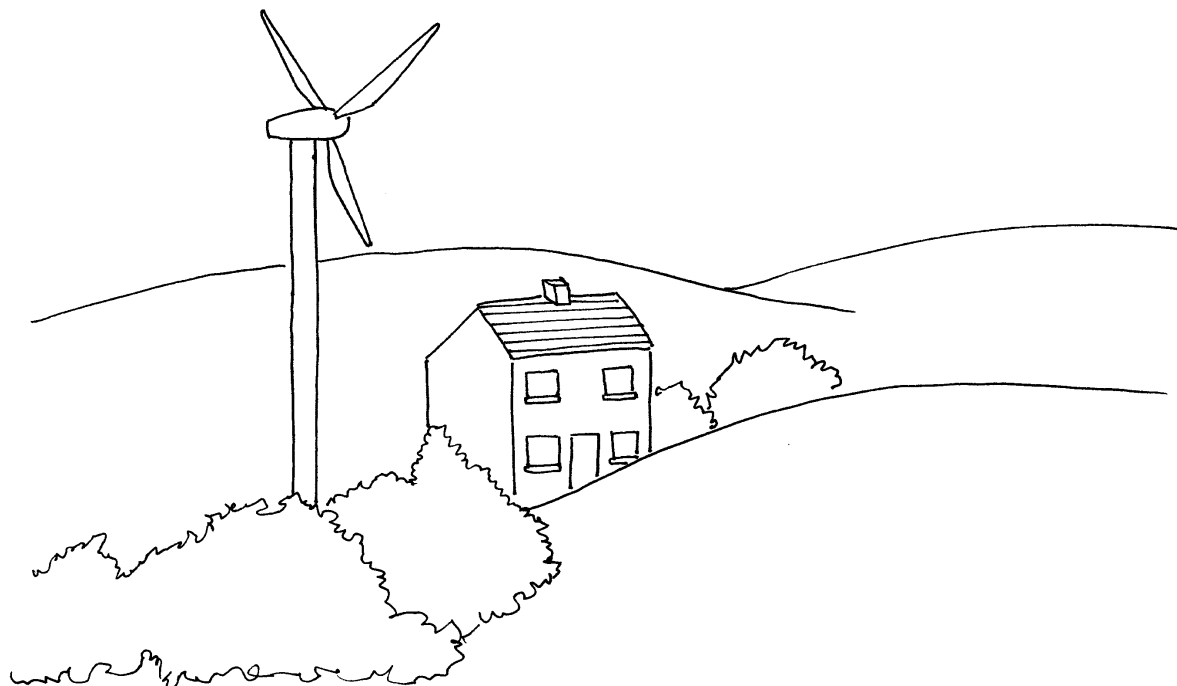

3.3 Hybrid Systems

A wind-hybrid system is the term used to describe a wind turbine that is used to produce energy in conjunction with a second type of generator such as a diesel generator or a second renewable energy source. The second generator works to supplement the electricity generated by wind power and helps to ensure that electricity is available during periods of calm weather or turbine maintenance.

3.3.1 Wind-diesel system

A wind-diesel system consists of an appropriately matched wind turbine with a diesel generator - the exact capacity of system components will depend on the application and the wind resource. These systems are commonly used in remote communities. Typically the wind turbine generation capacity ranges from around 10kW to 20kW. In such remote areas it can be expensive to generate electricity because of the cost of transporting diesel fuel to the users. Whenever it is physically possible, power is supplied from the wind turbine. This minimizes the use of the diesel generator and so can greatly save on fuel and maintenance costs. Often the load management of the output of such systems utilizes a battery bank together with a heating and/or refrigeration so that output can be dumped should battery charging not be required.

During calm periods, if the charge in the battery falls below a set level, the diesel generator will automatically start up to provide a power supply.

A wind-diesel system supplied by a reputable manufacturer and properly installed and maintained can be cost effective, as long as there is sufficient wind resource in the area where the turbine is sited.

Case Study - Holwell Farm, UK

Holwell Farm is situated in Widdicombe-in-the-Moor, Devon, England and located 1.5 kilometres from the grid. In the past, the power requirements of three household dwellings and the farm machinery was provided by three aging diesel generator systems. These diesel systems were becoming old, they were noisy and also difficult to maintain. As the site of the farm was so windy the owner decided to replace the diesel systems with a small-scale wind development.

A planning application was submitted to the National Park Planning Authority in January 1991. This was prepared by Farm Power Ltd who designed and installed the system, (contact details can be found in appendix 6). The details of the application included the specifications of two wind turbines. In December 1991 the application was approved on the condition that the colour of the turbines was agreed with the local **Planning Officer**. To avoid a detrimental visual impact, trees were planted around the turbines to act as a screen and the turbines were positioned as stipulated in the **planning consent**. The erection of one turbine began in January 1992 and was completed in February 1992. Installation of the second turbine for which planning permission was granted will remain an option for the farm owner in the future.

The diesel systems were replaced by a 20KW wind turbine with a rotor diameter of 8.8m in diameter, which is mounted on a **tower** with a **hub** height of 24.4m high. The **lattice** tower is supported by guy ropes. The turbine generates electricity at wind speeds in the range 2.5-12m/s. It is shut down manually when the wind speed reaches 25m/s in order to avoid damage from site turbulence. An asynchronous 3-phase generator

provides the transformation of the rotation of the turbine to electricity. This generator charges a battery, which has a storage capacity of 120kWh and supplies electricity to the houses via an inverter.

Farm Power's "Powerminder" system is used in this example to control the battery charging, diesel generator cut-in and power supply to the farmhouses. The use of this control system ensures that mains quality electricity is always available. It also determines the cut-in of the diesel generator to ensure that there is full battery charging after discharging to 20% in times of low wind, or when the electrical demands are high.

The total cost for this development was approximately £100,000 (154,000 Euros at a rate of 1.54).

This cost included the following:

1. turbine
2. diesel generator
3. battery
4. control system
5. underground cabling to farm houses
6. system design
7. preparation of the planning application

This project was financed from the owners private resources and by a grant of £15,000.

ETSU (contact details in appendix 6) has produced an information sheet on this case study which offers facts on the operating experience of the project. The information sheet states that although there have not been any major problems, the turbine has been damaged by two indirect lightning strikes. The cost of repair was covered by the guarantee so did not fall to the owner. To solve earthing problems which were caused by the rotten granite beneath the site of the turbines, 200m of copper strip was laid to ten earthing pads, thereby re-routing future strikes. Wood laminate turbine blades covered with epoxy resin were fitted in place of the originals. This was because the original blades had cracked due to the turbulent nature of the site which lies below a ridge partly shielded by trees.

There were a number of benefits to this project:

1. Provision of a convenient and reliable electricity supply for the farm dwellings
2. 90% savings in running costs when compared with the diesel only system
3. A reduction of the amount of greenhouse gases emitted to the atmosphere from the farm

It should be noted that the turbine has not caused any disturbance to local residents or to the livestock.

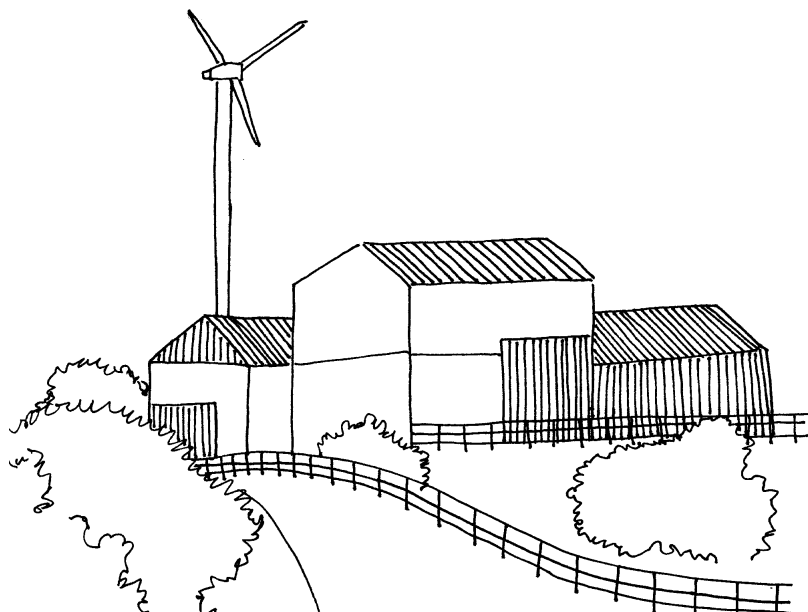

Russia

In 1998-1999 several wind turbines with a capacity of 1.5kW and 10kW were installed in the Murmansk and Arkhangelsk regions of Russia. Eleven villages which were previously supplied electricity by diesel generators, were chosen for the installation of wind turbines.

3.3.2 Wind-solar PV Systems

Electrical energy can be harnessed from the conversion of sunlight by solar photovoltaic (PV) panels. Although such solar PV panels are expensive, their availability as a power source is complementary to wind energy. Generally the potential for wind power is greatest in the winter months while the maximum output from solar PV is achieved on clear summer days. Hence the combination of the two technologies in a hybrid system has the potential to work well.

3.4 Grid Connected Applications

Grid connected turbines require connection to an existing electrical grid to provide power, and reactive power, which are needed for start-up, operation, and control of the wind turbine. The wind turbine starts to generate power at a **cut-in speed** - typically this is around 4 m/s for many modern turbines. An excitation current is taken from the grid and used to keep the wind generator in phase. This means that if the grid is out of action the wind turbine cannot produce any power. During operation, electrical energy produced from the wind turbine is fed directly into the electric utility grid.

Grid-connected developments focus on areas where there is a good wind resource and hence financial return on the scale of the electricity - e.g. commercial wind farms.

A wind farm is a development consisting of a cluster of several wind turbines often installed in rows, which are perpendicular to the wind direction. When the building and installation of such a project is undertaken the developer needs to take into account the provision of access roads, a substation and a monitoring and control system. This land is usually used for other purposes as well, such as agriculture.

Such wind farms may use wind turbines with a generation capacity ranging from around 200kW up to 1.5MW or even higher. This type of system is becoming more and more common to meet individual European countries targets to cut greenhouse gas emissions under the Kyoto protocol. Clusters of large wind turbines are located in relatively windy areas and create a **wind farm** from which power capacities can be in the multi-megawatt range.

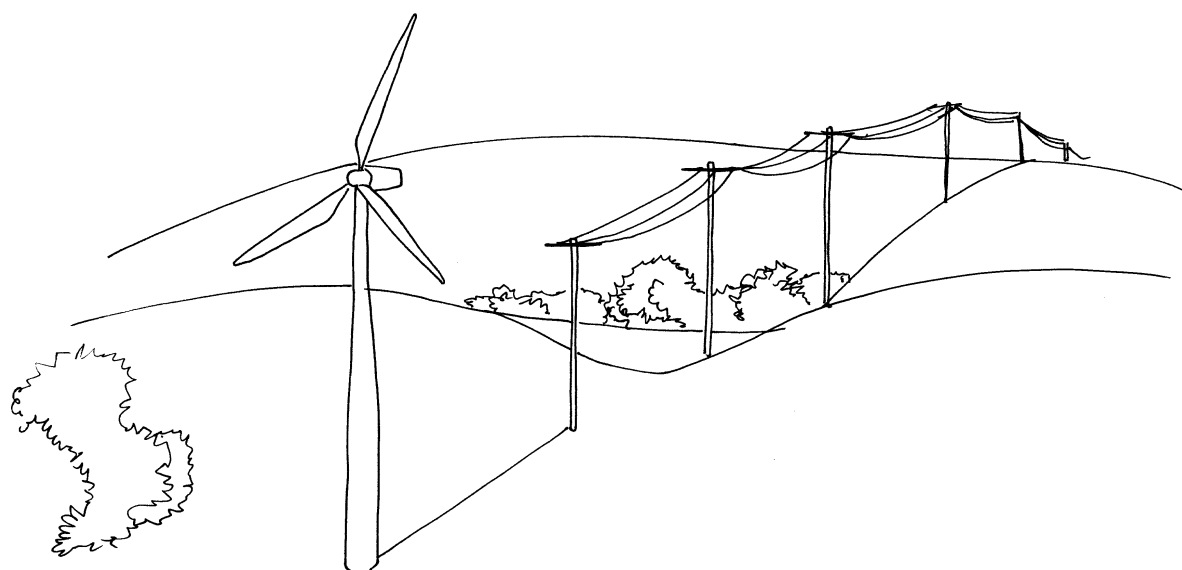

Businesses or individuals sometimes install one or more large scale wind turbines and may sell the electricity to the electricity suppliers so that their wind application is connected to the grid. In this instance there may be good financial return on power sales.

When the prime purpose of the power generated is used to help meet the business's electrical demand, power is still available to the business premises from the grid whenever the wind turbine output is too low. If there is more than enough power generated from the wind turbine to supply the business concerned with its electricity demands the surplus goes to the grid.

3.4.1 Connecting to the grid network

If you want to connect to the grid network you need to find out if the network is actually strong enough to carry the power generated from the wind turbine/s.

The strength limitations of the network can influence the size and capacity of the wind turbine/s that are selected for a development at a given location. Network limitations should be checked with the appropriate regional electricity company. For example, in Northern Ireland this is Northern Ireland Electricity plc.

3.4.2 Cost of grid connection

Grid connection costs will depend on the location and strength of the grid. If the grid needs to be strengthened the capital cost will likely be high and could be prohibitive.

Regulations for connecting to the grid will vary from country to country therefore contact the local network operator for details.

CHAPTER 4

Development of a wind project

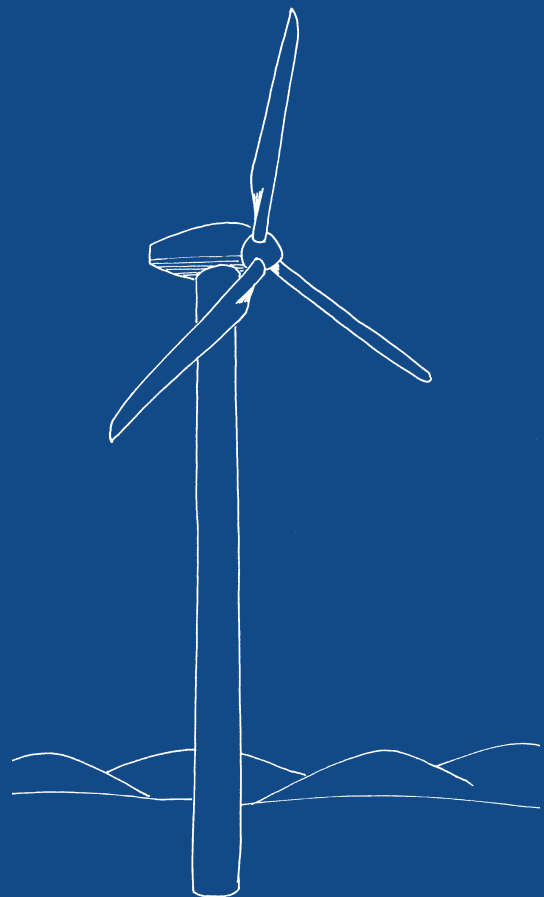

4.1 Introduction

If you have decided to move ahead with a wind development it is very useful to have a project checklist and guidelines on best practice. One 'checklist' that is very easy to follow is the EWEA flow chart which is very similar to that provided by the British Wind Energy Association (BWEA)⁸.

The EWEA was established in 1982 as a professional association for those involved in wind energy research and development. It also acts as the trade association for the wind energy industry (contact details in appendix 6).

The Best Practice Guidelines were drawn up by the EWEA with the participation of a range of organisations with the aim to ensure that projects continue to be appropriately sited as well as sensitively developed. These guidelines which are very general are indicative only. As the nature of wind energy developments can be very complex, projects should be assessed on individual merits.

It must be remembered that although the guidelines cover all scales of projects the work required by a developer in project design and environmental assessment will depend on the nature, size and location of the proposed project.

The EWEA/BWEA development flow chart outlines the chronological flow through the necessary phases in the development process. These seven phases are considered under the following headings:

- **Site selection**
- **Project Feasibility**
- **Assessment**
- **Planning**
- **Construction**
- **Operation**
- **Decommissioning and Land Reinstatement**

Each of the phases will require the following considerations:

- **Technical and commercial considerations**
- **Environmental considerations**
- **Dialogue / consultations.**

In the following chapters of the handbook various aspects relating to these considerations are presented.

BWEA/ EWEA Development Chart for Wind Energy

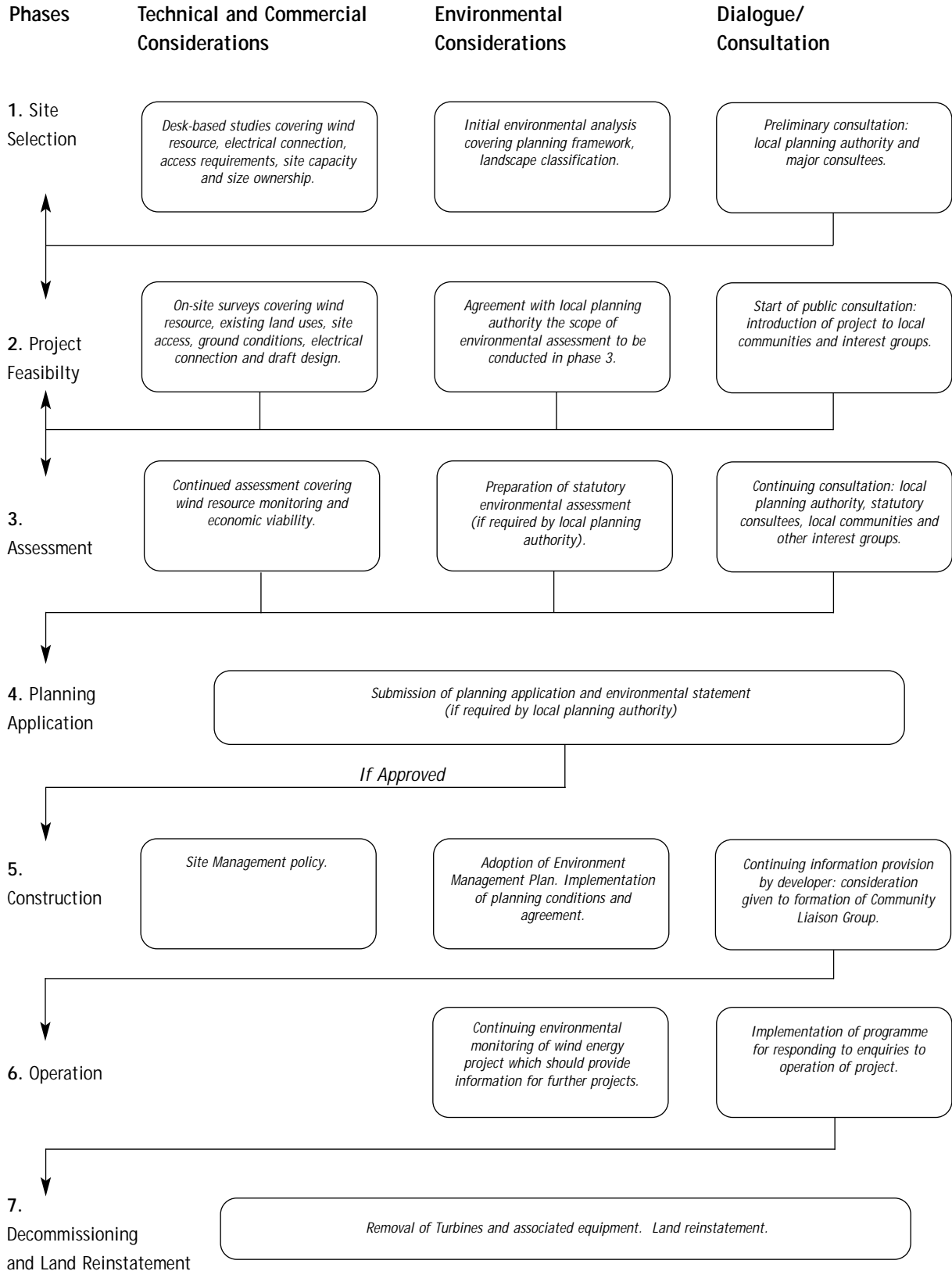

CHAPTER 5

Financing a Wind Energy Project

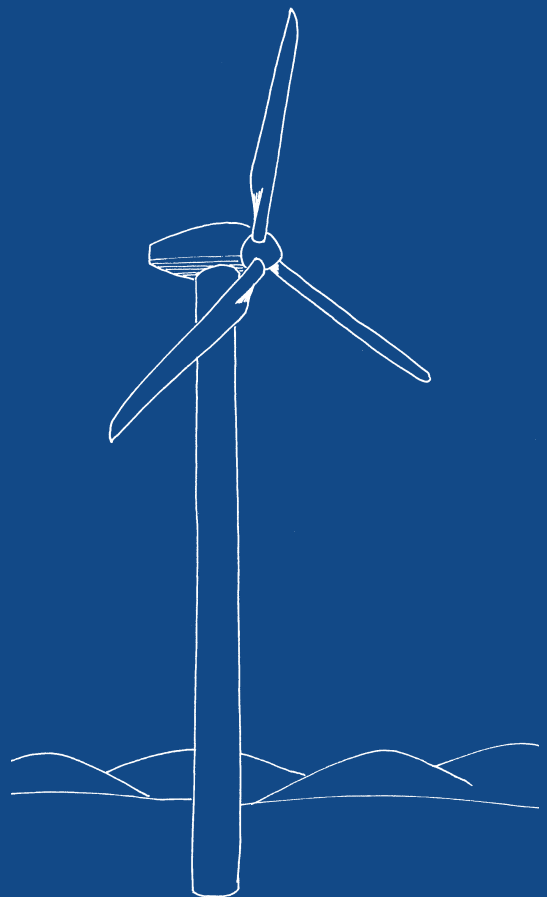

5.1 Introduction - Project Feasibility

Before embarking on the development of a wind project it is important to complete a feasibility study. This study examines the possibility of erecting a turbine and associated costs etc. The study may be carried out by consultants and may take around 3-12 months to complete depending on the scale of the project. When this study has been completed and the wind potential confirmed, project financing needs to be considered.

5.2 Costing a Wind Project

The costs of the project will fall into two main categories, the initial capital investment and the annual recurring costs. The following are some examples of costs listed under each heading.

5.2.1 The Initial Capital Investment

Costs of any preliminary studies

These include the feasibility study itself, and the initial designs.

Costs of obtaining planning permission

These costs include the actual application to the planning department. This also includes the price of an Environmental Impact Assessment (EIA) the study and the resulting report which is called an Environmental Statement (ES). The ES is submitted in conjunction with the planning application. In most areas of the UK a comprehensive ES will be required to support a planning application.

Project management costs

This may only be applicable for large scale projects, but even in small scale projects it is likely that a portion of the suppliers costs will go towards the management of the project.

Legal fees

If the project was owned by a co-operative, legal fees would include individual contracts, distribution of shares and associated costs.

Purchase of the wind turbine/s

This includes all the equipment actually needed to undertake the project.

Infrastructure costs

This includes cables and foundations. For larger scale projects this may include constructing access roads.

Installation, delivery and commissioning charges

Usually, the supplier will charge delivery at a certain amount per mile or kilometre plus a standard charge. The installation and commissioning charges may be included in this, but this should be confirmed with the supplier - a full cost-breakdown should be obtained. Also depending on where the turbines are manufactured an import duty may be charged.

Charges for any additional warranties

Possible guarantees on individual parts of the turbine/s.

Fees for the arrangement of finance and provision of capital

If the turbine/s are financed by a bank loan the bank will charge arrangement fees etc.

Costs of connection to the local electricity distribution system

This is only applicable to wind projects that are going to be connected to the local electricity grid. This cost could include the transformer, additional cabling required etc.

5.2.2 Recurring Annual Costs

Insurance fees

The supplier should be able to insure the wind turbine/s for the purchaser/s. This is extremely important. For example if after the guarantee period there was a technical problem with the turbine or at the project outset if there was any damage from a lightning strike etc. then the owner would not have to pay for the repairs. In some areas of Europe general insurance for turbines is issued through a specialised broker.

Payments to land owners

If the turbine is sited on land not belonging to the developer a rental agreement will have to be negotiated with the landowner.

Operation and maintenance costs

Turbine components will need to be serviced and some parts may need replacing occasionally. The frequency of the maintenance may depend on the complexity of the equipment being used but in most instances it will be once or twice yearly. This can be a considerable cost.

Interest payments on borrowed capital

If capital is borrowed e.g. from a bank it will need to be paid back under the terms of the loan agreement.

Other costs

A grid connected wind development will incur extra costs e.g. charges for importing electricity during start-up and reactive power during operation. For Stand alone systems other costs may include back-up fuels, replacement batteries etc.

Another cost that must be taken into account is the cost of dismantling the turbine/s at the end of their useful life and returning the site to its former state.

5.3 Financing a Wind Development

Depending on the size of the development private individuals, community groups may finance wind turbines from their own funds. Where the individual or group have insufficient capital to invest in such a project a bank loan will be need to be arranged.

5.3.1 Typical Information Required by a Bank to Support a Loan Application

1. A description of the project, its location, the planning requirements and other permits, and local reaction.
2. How much capital is required?
3. Requested loan duration?
4. What length of payback time is expected from the wind turbine/s?
5. Estimated total project costs
6. For a stand alone system, how much money will be saved in comparison to connecting to the grid?
7. Evidence of continuous availability for the money needed to pay back a loan ie loan security.
8. If the development is large scale and commercial, projections of profit from the price being offered per kWh would be essential.
9. What are the annual maintenance costs for the turbine/s and how they are going to be met?
10. A cash flow prediction with accompanying profit and loss account and balance sheet.

When costing a project one should allow for an 18% income of the capital costs. If the cash flow prediction is correct this will allow for a reasonable profit for a wind development.

CHAPTER 6

Planning

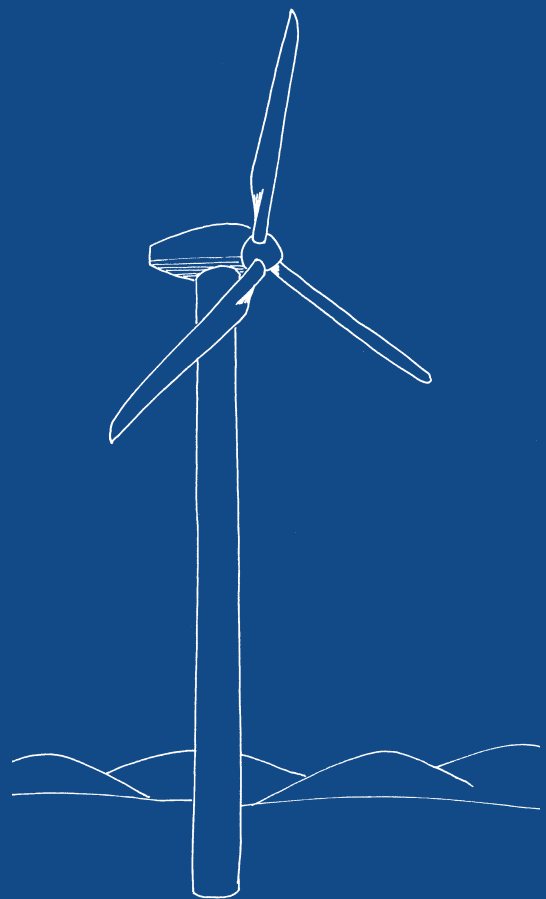

6.1 Introduction

The first phase of any wind energy development is site selection. It is necessary to choose an area, which is likely to have good wind speeds, and then identify the best sites within the search area. Where possible, readily available technical and environmental published data should be sought. Identification of suitable sites is usually achieved using a combination of local maps and wind speed computer modeling. Initial planning and environmental considerations are also carried out during this phase.

6.2 Obtaining Planning Permission

A successful planning application for a wind project will often depend on a number of planning considerations. You should contact your local authority to determine what these are. The planning authority may need to do an assessment of your site. When doing this the planning authority will take into account the height of the turbine and whether it is one turbine or a wind farm. Before planning permission is sought you must confirm that there is a sufficiently good wind resource, with high annual average wind speeds ensuring high energy yields from the turbines and therefore resulting in a reasonable return on the capital invested.

6.3 Siting

The site must provide a technically and commercially feasible point of connection to the local electricity distribution system. The site must cover sufficient area to accommodate the number of wind turbines required for economic viability along with meeting other site specific planning considerations.

Civil works access will also be taken into consideration therefore, for large wind developments, it is important to have adequate vehicular access to the site. The local terrain and topography and the ground conditions will also be taken into consideration. The siting of the turbine/s should be considered carefully when designing the development so that wake effects are kept to a minimum. Wind turbines are sited away from obstacles on the ground so as to avoid the effects of wind shelter and undesirable wind turbulence.

The effect of **wake interaction** forces the location of the wind turbines to be spaced 5 to 10 rotor diameters apart. Wake interaction is used to refer to the trail of '**dirty wind**' that a wind turbine will leave in its wake. Any turbine operating in dirty wind will have a significantly reduced energy output, and be liable to experience increased fatigue loads.

The foundations for the wind turbines need to be constructed on ground conditions, which can cope with not only the weight of the foundations but also the weight of the actual machines on top.

6.4 Environmental Considerations

The success of the planning application may be influenced by the nature, size and location of the proposed wind energy project as well as the views that the local planning authority have on such projects.

In the UK an Environmental Impact Assessment (EIA) is carried out on most wind developments. Although some of the topics may not be appropriate for one stand alone turbine, they are a useful source of reference that consultants will take into consideration when producing an Environmental Statement.

The following are topics that a planning authority will often take into account when considering a planning application.

■ *Designations*

A protected designated area is a particular area that has been identified as being an area of particular environmental importance. This may be due to attractive scenery or perhaps rare flora and fauna. This area may be important on different scales, internationally, regionally or locally. As such, designated areas are to be protected. They are usually subject to a high level of development control. Depending on the reasons for the designation, it may still be possible to develop a wind energy project but careful considerations need to be adhered to.

■ *Visual & Landscape Impact*

As part of the visual assessments, **zones of visual influence maps** are used. These indicate points from which the development may be visible within a given radius agreed with the planning authority. The visual impact of both the wind turbines and the power transmission lines from the site need to be assessed.

■ *Archeology & History of the site*

The siting of wind turbines, their control buildings and access roads, should minimise the impact of the development on a site of significant archaeological or historical importance.

■ *Ecology*

There is the possibility that fragile ecosystems could be damaged during construction. Therefore information on ecological designations and protected species and conservation issues should be obtained from the Local Planning Authority and relevant nature conservation agencies.

Birds can be affected through displacement from an existing habitat or through impact with the rotating turbine rotor blades. However, studies of past construction monitoring from a range of sites across the UK have shown that the effects of wind turbines on bird life are small as long as the possibility of using sensitive habitats has been taken account of at the planning stage. For more information on this topic see "Birds and Wind Turbines: Can they co-exist"³.

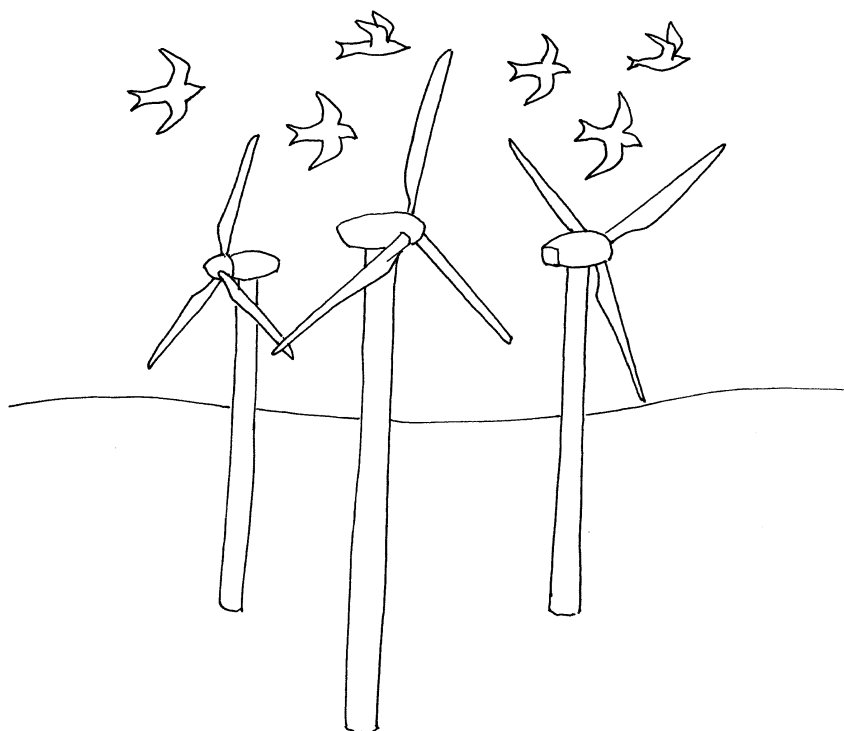

■ *Hydrology*

It may be necessary to assess the potential impact of the project on watercourses. The reason for this being that the construction of access roads and the need for drainage can impact on the quality and quantity of water courses.

■ *Noise*

In the United Kingdom a prediction of the noise produced by the proposed development should be made and then should be presented in an agreed form to the Local Environmental Health Officer.

Wind turbines generate two different types of noise from the blades (a swishing sound) and mechanical noise from the rotating machinery. It is the noise, which is predicted at nearby domestic dwellings that will usually determine the minimum separation distance between the wind turbines to the dwellings.

■ *Interference with telecommunications systems*

Interference with television and microwave transmissions can result from wind turbines. Potential problems relating to microwave links can usually be avoided by re-siting the turbines or the links. Local technical solutions such as serial realignment or the installation of a self-help booster relay may address effects upon television reception.

■ *Aircraft safety*

Wind turbines can be potentially hazardous to aircraft safety. This is due to the potential effect on rotor systems or low flying aircraft, but problems of this nature are site specific.

■ *Safety assessment*

Properly designed and maintained wind turbines are safe, but the Health and Safety Officer should be consulted so that measures can be taken to protect the public and site personnel. Safety aspects will be discussed further in Chapter 10.

■ *Traffic management & construction*

Local residents may be affected by slow moving traffic delivering wind turbine parts but this is usually a short term issue unless it is a major development requiring changes to the infrastructure etc.

■ *Electrical connection*

The emphasis of this handbook is on off grid systems, but as electrical connection is required to make the project on grid the local electricity supply board should be contacted. If the Regional Electricity Company will be buying the electricity, a power line will be needed to link the site to an existing power line or substation. In the UK this power line is usually installed by the relevant utility. This electrical grid connection, will normally require a planning application and an environmental impact assessment to be submitted by the wind developer.

The provision of electrical connection can be by overhead or underground power lines. Visual intrusion of overhead power lines can be an issue and so it is now common practice to have underground power lines.

■ *Atmospheric emissions*

Although wind power for generating electricity does not produce any direct atmospheric emissions indirect emissions are produced as a result of the construction of the site and the production and transportation of the materials and equipment. This is not a major problem because the more electricity that is produced by renewable sources the lower the quantity of fossil fuels used for the same purpose.

■ *Tourism and recreational issues*

There can be a considerable impact on the recreational amenity of the local area where there is a wind development. This is not usually a problem for small scale developments but may be so for larger wind farms. Wind turbines can attract tourism to an area or they can be looked upon as an eye sore. It is important that public rights of way on the site should be identified.

■ *Socio - economic issues*

The following are a number of ways that a wind development may have direct economic impact in the **short term**:

- Manufacturing The provision of the turbines or perhaps components
- Construction Provision of infrastructure
- Miscellaneous Input into the local economy e.g. provision of accommodation for site workers etc.

long term:

- On going operation and maintenance work (O&M).
- Project revenue
- Land rental
- Rates
- Insurance. Owners will want to insure against unforeseen circumstances.

■ *Decommissioning*

Wind turbines can be removed and reconditioned or used as scrap after they reach the end of their useful life (around 20 years). Decommissioning will usually be part of a planning condition so that restoration measures for the removal of above ground equipment, landscaping of the foundations and consideration of whether site roads will re-seed naturally or will require treatment all need to be taken into account.

CHAPTER 7

Public Acceptability

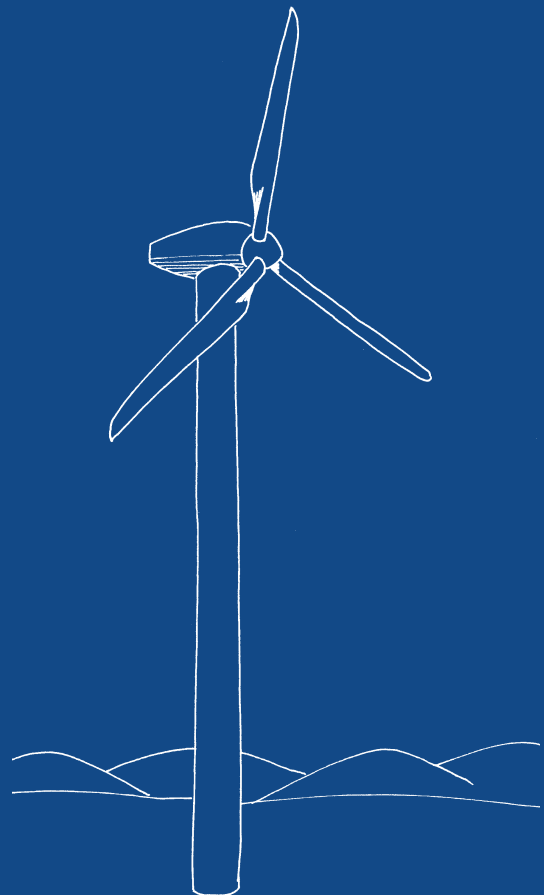

7.1 Introduction

Public Acceptability is crucial to continue and develop general support for wind energy and to stimulate demand for “green” electricity. Society recognises that renewable energy development is a priority but only in general terms. People now associate the change in weather patterns across the globe as something that may have resulted from the over use of fossil fuels causing global warming. They realise that action must be taken to stop the problem becoming any worse, but this global concern is not necessarily reflected by the local public support given for specific wind energy developments.

7.2 Involving Communities

Recommendations to gain and maintain public support:

- During the development of a large project there should be appropriate public consultation.
- After construction, appropriate access should be provided to local communities for tourist, public and educational activities
- Information on the project should be available for primary, secondary and tertiary educational levels
- Information should be available to the public on the benefits and role of wind energy

The European Commission suggests that it is important to establish clear targets for community contributions towards renewable energy. If communities see it as their responsibility to meet renewable energy targets they will more readily support local developments in wind energy.

7.3 Benefits of Wind Energy to the Public

There are a number of local and global benefits that wind turbine developments provide to the public. These may stem from a single off-grid turbine, or from a large wind farm development.

The following are some examples of benefits:

- The possibilities of independent electricity supply – ie. not reliant on the network
- Efficient ‘Embedded’ generation connecting into the local electricity network, rather than the transmission system which will have higher system losses.
- A reduction in the amount of gaseous emissions polluting the environment as the community is using less fossil fuels.
- The facility to demonstrate renewable energy through wind power to other communities as well as schools and colleges.
- The possibility of financial gains.

7.4 Wind turbine co-operatives and other types of ownership

The initiative and involvement from the private sector has been the driving force behind the wind energy development in Denmark. Around 70% of Danish wind turbines are privately owned. These turbines are either under single ownership or owned by a co-operative, with over 60% being under joint ownership. In Denmark when wind developments first started, a typical wind turbine co-operative involved 5-50 families, who joined together to establish a local wind turbine. Co-operatives have resulted in a range of developments from single turbines to large wind farms with 10 to 30 wind turbines.

Other types of ownership options that could be explored include:

Small group-led

An example of a small group would be landowners/farmers/SMEs. Their principal intention would be to generate grid-connected electricity and sell power as a commercial activity.

Developer-led

A developer may take such a wind project from the beginning and following the commissioning stage sell the project on to a group. The developer may continue to benefit from this by taking on the management of the project and perhaps the operation of the equipment.

New group-led

This is when a group will form especially to control the development of a wind project. They may take on a developer to manage the project.

Existing group-led

This is a project developed by an existing group. This could be a charity or similar type of organization. Often this type of group will not widen their investment outside the group.

Further information can be obtained from a booklet produced by ETSU called "Community involvement in renewable energy projects: A guide for community groups"⁶.

CHAPTER 8

Wind Development Time Scenario, Maintenance and Health and Safety

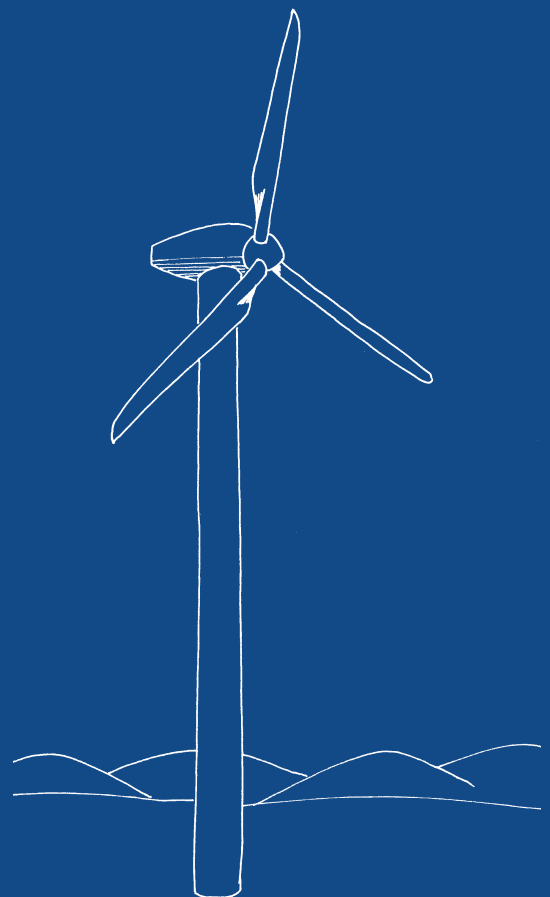

8.1 Time Scenario

The length of time that it takes for a wind project to progress from the planning stage to energy production depends on the size of the project and how quickly the parties involved complete the various stages of the development. For example, the planning authority in one country may provide decisions on planning applications on a shorter scale than a similar authority in another country.

8.1.1 Off-grid Application *Case study - Holwell Farm*

In chapter 2 the example case study of Holwell Farm, Widecombe-in-the-Moor is given. The planning application for this system, which provides enough power for three dwelling houses was submitted in January 1991, and the erection of a 20kW turbine was completed in February 1992. Before the planning application is submitted there needs to be a study into the wind levels which will typically last between 3 and 12 months depending on the size of the project. In this example planning permission was not confirmed until December 1991, in most other cases it is likely that the planning decision would be made in a shorter length of time.

8.1.2 Grid Connected Application *Case study - Abbey Produce*

The case study of Abbey Produce, potato merchants and produce handlers who are situated in an open fenland location in Cambridgeshire, England is given in Appendix 5. This project involved the construction of a 225kW grid connected turbine, the planning for which started in 1990 and the turbine was installed in the Autumn of 1993.

8.2 Maintenance

When a feasibility study is being drawn up for a wind development it is important to remember to take into consideration the fact that once the wind turbine is operational there will be on-going maintenance needed to ensure that the turbine/s are as productive as possible.

8.2.1 Maintenance for off-grid small scale wind projects

1. Ensure that batteries are well maintained. For example, Nickel Cadmium batteries must be fully discharged occasionally to maintain full capacity.
2. The overcharge sensor must be regularly serviced.
3. Inverters need to be serviced on a regular basis so that they can withstand a large variation in supply voltage since this will vary over a wide range in the battery charge/discharge cycle.

8.2.2 Maintenance for large scale wind developments

1. Once a turbine or wind farm has been commissioned regular visits are necessary to make sure that the turbines are working correctly.
2. If the development is a large-scale commercial wind farm it is recommended that the turbines be connected via a computer to a remote monitoring network so it is quick and easy to monitor them from a distance.

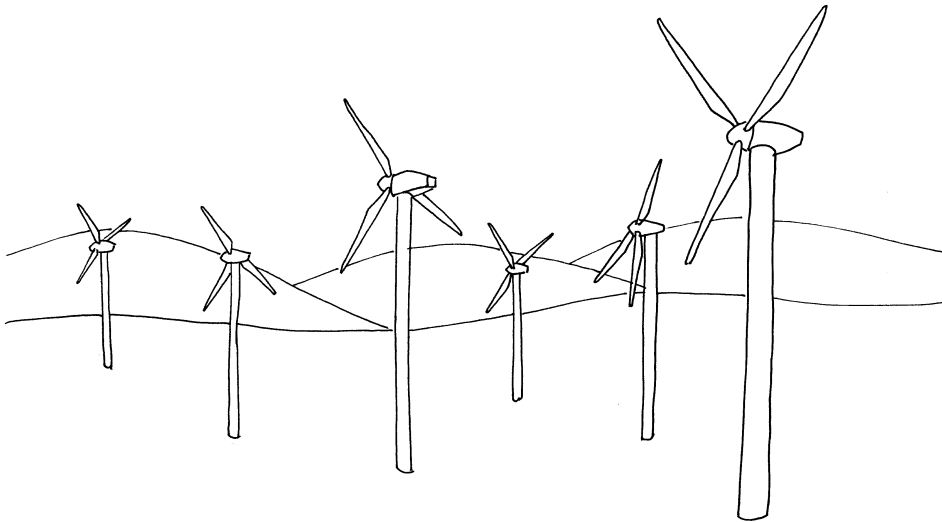

8.3 Health & Safety

8.3.1 Turbine safety issues

So as to allow for maintenance etc. most wind turbines have two independent braking systems, which are as follows:

1. aerodynamic braking (e.g. rolling the rotor out of the wind direction, changing the pitch of the blade tops)
2. mechanical braking (usually a disc brake in rotor shaft or gearbox shaft)

The rotor and tower must be robust enough to survive the strongest gales likely to occur on the site when the brakes are applied. Should the wind development be in a cold climate then there are special rotors that can be used which are designed to cope with the build up of ice on the blades. Lightning protection is provided on a wind turbine.

8.3.2 Maintenance procedures

Electrical safety is a major consideration with any wind turbine. Even with relatively small machines sufficient current may be present to cause injury or death. The relevant standards and publications relating to turbine operation and maintenance are listed under 8.3.3 publications. In stand alone systems care must be taken when using lead-acid batteries due to the risk of fire or explosion from hydrogen gas that is generated during the charging of the batteries.

It is important that specific safety precautions are followed when maintenance procedures are being carried out. During installation all of the electricity works have to comply with the national wiring regulations and standards. If the turbine or turbines are grid connected then more particular regulations are required. For

example, if a turbine was to start generating while the grid supply was out of action, the grid maintenance staff could be in danger of electrocution.

It is extremely important that the people who design the wind power systems take a number of points into consideration in relation to maintenance procedures.

1. The guarding of rotating components inside the **nacelle**
2. Methods of preventing the rotor from turning during maintenance
3. Difficulties of working in a confined space within the nacelle
4. Emergency lighting within the nacelle and tower
5. Access ladders, and places to rest during the ascent of the tower
6. Safety harness provision
7. Particular hazards of solo working and methods of communication

Any person who may be operating or maintaining a wind system must be properly trained to do so. This training must cover emergency procedures, how to check the safety equipment and also how to disconnect the electrical supply and apply the brakes before attempting to service any of the machinery. As well as providing this training, in the UK, a business which employs five or more staff must prepare a written risk assessment which should include wind turbine operations and comply with Management of Health and Safety at Work Regulations (Windpower: A guide for farm and rural business, 1998).

8.3.3 Publications

In the UK, there are two British Standards publications that one can consult for safety issues. They are:

1. Wind turbine generator systems: Part 1 - Safety requirements (DD ENV 61400 - 1: 1995)
2. Wind turbine generator systems: Part 2 - Safety of small wind turbines (BSEN 61400 - 2: 1996)

There are also equivalent International Electrotechnical Commission Standards (IEC 1400 - 1: 1994 AND IEC 1400 - 2: 1996).

In relation to wind power in the UK there are other important standards to adhere to:

1. Electricity at Work Regulations 1989
2. Health and Safety at Work Act 1974
3. Provision and use of Work Equipment Regulations 1992

CHAPTER 9

Frequently asked questions

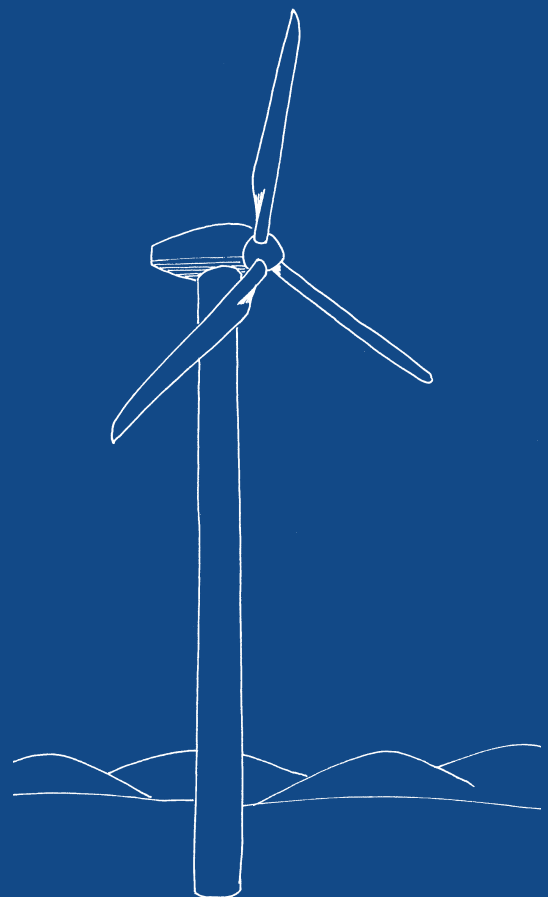

How much will it cost?

This is the most frequently asked question and the answer depends upon a number of issues, such as how big or small the project is, where it is to be sited, if the infrastructure is already in place, etc. For more details refer to the project feasibility and finance section.

How do I find out who is a registered supplier of equipment?

In mainland Europe the European Wind Energy Association (EWEA) acts as the trade association for the wind energy industry. For contact details see appendix 6. In the UK the British Wind Energy Association (BWEA) also acts as the trade association and can provide a list of registered suppliers.

How do I find out the size of the turbine needed for my business / home?

This depends on what you want the turbine to power and how much power is required to run your home or business. If you get in contact with reputable suppliers they often advise you of the size of turbine that you will require. Fact sheets are also available from the BWEA.

Is there strong enough wind in my area?

To find the answers to this question contact the BWEA or/and your local meteorology center. They will have access to a database of wind speeds for your area of the country.

You should ascertain annual mean (average) wind speeds in the area where the development is to be sited. This will help you determine if a wind project is a viable option. However to determine accurate energy yields at a given site it is necessary to undertake wind speed monitoring. Suppliers usually provide this service.

CHAPTER 10

Conclusions

Conclusions

This handbook provides a basic layman's guide through the necessary topics and considerations to be made, which affect the development of a wind turbine system. The handbook concentrates on off-grid systems but also refers to grid connected systems so that the reader can obtain a deeper knowledge of the various types of and uses for wind turbines.

This handbook provides information on how the wind power available to people can be harnessed, case studies on various types of systems which include examples of cost, details on how to cost a development, planning, types of ownership and much more.

Very importantly, there is reference to the British Wind Energy Association guidelines and a reproduction of its development chart. The guidelines relate very closely to the information given in the chapters of the handbook. Although the development chart is quite detailed it is easy to follow. Every wind development is different and some development issues will be more important to certain projects than others. The development chart can be used as a general guide to understand the usual processes of developing such a wind system.

This handbook has shown that everyone who has a strong and frequent enough wind resource (see section 1) can use wind development systems in some form or another. There are many scales in which wind turbines can be used and the opportunity for the use of wind turbines to cut electricity costs for individuals, and SME's such as farmers can be tremendous.

In the future it is very likely that renewable energy sources such as the use of wind turbines will become more and more popular as people realise that it will be in their best interest to change the energy source from which they derive power for utilities etc. As the reserves of fossil fuels rapidly deplete renewable sources will be used more and more.

CHAPTER 11

Bibliography

Bibliography

1. *Renewable Energy Advisory Group: Report to the President of the Board of Trade*
Energy Paper 60 (HMSO, London, 1992)
2. Troen & Petersen (1989) *European Wind Atlas* Roskilde, Denmark; RISØ National Laboratory
3. ETSU, ITE, BWEA and Alterner (1996) *Birds & Wind Turbines: Can they Co-Exist?* Seminar Proceedings
4. Kirk McClure Morton, National Wind Power, Brady Shipman Martin, Harland & Wolff SHI and Queens University Belfast. (1999) *Assessment of Offshore Wind Energy Resources in the Republic of Ireland and Northern Ireland*. Produced by the DETI and DPE under INTERREG II.
5. Associated Energy & Environment Offices, The Danish Organisation for Renewable Energy (1993)
The Sustainable Energy Handbook: for NGO's and local groups. Denmark - ISBN 87-87660-72-5
6. ETSU for the DTI *Community Involvement in Renewable Energy Projects: A guide for community groups*
7. The Secretariat of the European Wind Energy Association *European Best Practice Guidelines for Wind Energy Development*.
8. Centre for Alternative Technology Education *A Pupils Guide to Windpower* (1997) CAT Educational Publications: Newtown

CHAPTER 12

Appendices

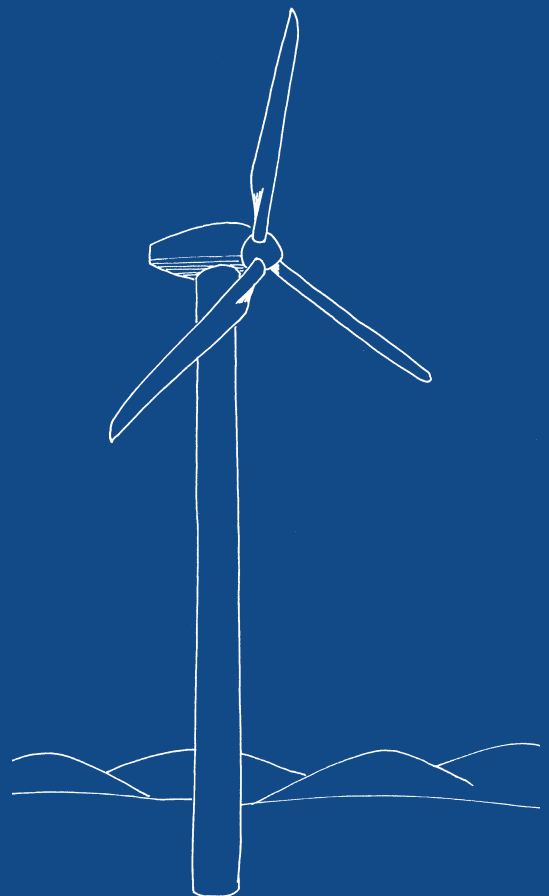

APPENDIX 1

Glossary

Autonomous Turbine	A stand alone system running without any other generator.
Cut Wind Speed	The speed, which the turbine begins to produce electrical output.
Electricity Current	Alternating current known as a.c. is now produced from nearly all electrical generators. Another type of current is d.c. using a rectifier which is a semiconductor device built into wind turbines so that the output is d.c. It is not easy to convert d.c. back into a.c. but if this is needed it can be achieved with the use of an inverter which is an object often used on wind powered systems to run mains powered equipment from batteries.
Voltage	Voltage is another difference between battery power and mains electricity but all of the equipment used is a particular type of electricity needing to have the same voltage rating so that it works properly. In the UK mains supply is rated at around 240volts a.c., whereas batteries may be around 12 d.c. In the use of either type of supply the voltage rating is nominal meaning that it can often vary by as much as 15% without upsetting the loads .
Current	A current is measured in amps which is the flow of electrons along a wire, which transfers energy from x to y. The higher the voltage, the more energy is carried per second with the same current. Using a higher voltage when more power is needed is cheaper than laying more or thicker cable to carry the current
Dirty Wind	See 'Wake Interaction'
Grid Connection	A system connected to the central electricity supply.
Gear Box	Most large wind turbine systems include a gear box, the generator running at a much higher speed than the rotor blades.
Hub	The fixture for attaching the blades to the rotor shaft. (Centre of blade diameter)
Hub Height	Height of the centre of the rotor above the ground.
Inverter	A device which produces alternative current from the output of a battery or other direct current source of electricity. Grid electricity has the form of a pure "sine wave". The highest quality inverters can produce such a sine wave output but the output from more basic converters may cause problems with certain types of electrical appliances.

Load	Quantity of electricity
Mast/Tower	Used to support the wind turbine. Often this will be a simple tubular mast, guyed with wires.
Nacelle	The housing which contains the drive train and other elements on top of a wind turbine.
Off-Grid Application/ Stand Alone System	A wind turbine development which is not connected to the electricity grid.
Planning Consent	Permission from the local Planning authority to site a Wind Development in a particular location.
Planning Officer	Official in Planning Department who may or may not grant permission to site a wind development in a particular area of land.
Rectifier	A semi-conductor device built into wind turbines so that the output is d.c.
Rotor Blades	The 'propeller', sails or wings of a wind turbine.
Survival of Wind Speed	The minimum wind speed required to make sure the wind turbines are productive.
Wake Interaction	When a turbine uses wind to drive the rotors it leaves a trail of used wind in its wake. This is sometimes referred to as dirty wind.
Wind Farm	A wind farm consists of an area of land on which the turbines are sited. Wind turbines are often installed in rows, which are perpendicular to the wind direction. The developer needs to take into account the provision of access roads, a substation and a monitoring and control system. Typically the site land is usually used for other purposes as well, such as agriculture.
Yaw	The orientation of a wind turbine to align the rotor axis more or less with the wind direction. Down-wind rotors often remain aligned with the wind of their own accord.
Zone of Visual Influence Maps	Maps showing the area over which the wind turbines can be seen.

APPENDIX 2

The History of Wind Power

It is not known who invented the windmill. Some people believe that the Chinese invented the first windmill while others think that it was the Babylonians or the Persians. However, we do know that people used wind power to drive boats at least five thousand years ago on the river Nile in Egypt. Wind has been used as a mechanical power source for over 2,000 years with windmills being used in agriculture for grinding grain to make flour.

In Britain during the Middle Ages windmills were quite a common site. By the early nineteenth century there were over 10,000 Dutch style windmills in use in the UK. These types of windmills would have produced a peak mechanical power output equivalent to 30kW which was about an average of 10kW throughout a year. This type of windmill would do the same work as about 200 people.⁹

Today's modern wind turbines convert mechanical power to electrical power, but they have their origins in the windmills in the past.

Wind turbines have begun to make a large impact worldwide with more than 20,000 turbines now deployed. For example, at Altamont Pass, California, USA there are over two thousand turbines. In Europe, the leaders in wind development are Denmark, Holland and Germany.

We all know that in a lot of places the wind blows almost all the time, whether this is at force 1 or force 10. If the population in the world could use only 0.5% of the energy in the wind flowing around the planet, there would be more energy than the world uses at present. In saying this, all of the countries in the world do not have the wind resource required for wind developments and those that have cannot rely on the wind being in the right place at the right time all of the time.

In the future oil, gas and coal prices will continue to rise and fossil fuels will become more limited. The most important uses for fossil fuels will become recognised making the arguments for using renewable energy in Europe and indeed all over the world even stronger than they are at present.

APPENDIX 3

Units of Measurement

M Meters

M/S Meters per Second

Gigawatts, Megawatts, kilowatts and watts A gigawatt (GW) is equal to 1,000 megawatts. A megawatt (MW) is equal to 1,000 kilowatts (kW) or 1,000,000 watts. They are units used to measure electrical capacity

kWH Kilowatts per Hour

KM Kilometers

T Tonnes

V Volts

W Watts

APPENDIX 4

Abbreviations

A.C.	Alternating Current
D.C.	Direct Current
EIA	Environmental Impact Assessment
EIS	Environmental Impact Statement
ETSU	Part of AEA Technology Environment-a business of AEA Technology plc.
EWEA	European Wind Energy Association
NFFO	Non-Fossil Fuel Obligation
OPET	Organisation for the Promotion of Energy Technologies
REC	Regional Electricity Company
RPM	Revolutions per minute (Rotational Speed)
SME	Small Medium Enterprises
SRO	Scottish Renewables Organisation
WREAN	Western Regional Energy Agency Network
UK	United Kingdom

APPENDIX 5

Case studies from various European Countries

OFF GRID APPLICATIONS

1. Case Study - Lithuania

In Lithuania low power autonomous wind turbines of between 20 and 60 kW are particularly suitable for domestic power supply where there is no grid connection. Individual farmers, collective farmers, small manufacturers and other users own the turbines. To ensure a continuous electric supply, accumulation batteries, small power-storage plants or diesel aggregates must be used. Off-grid low powered wind turbines are used to heat dwelling houses by either transforming electrical energy to heat or by units that transform mechanical friction power to heat.

An example of such a turbine was erected near the municipality waste treatment plant in Kaunas, Lithuania. The plant is located on the top of a hill and the nearby turbine quite provides power for the plant and surrounding houses. For these houses the fuel saving is very significant.

Where the turbine is located it benefits from wind speeds of 4.5 m/s. The turbine starts to generate at a cut-in wind velocity of 4 m/s. The 12.6 diameter, three-blade rotor is on the upwind side of the tower. The rotor is turned towards the wind by electric yaw motors acting on a yaw ring with internal gearing. The lattice tower gives great strength in relation to the weight of steel used and it is easily transportable.

2. Case Study - Dwelling House, Dartmoor, UK

Another example of this type of application is a dwelling in Rundlestone, Yelverton, Devon in the Dartmoor National Park which is owned by Mr Rod Seward.

Mr Seward's closest neighbour lives 0.5km away from him, and the electricity grid is 1km away. Before 1992, Mr Seward used a small diesel generator to supply electricity to his home. This was satisfactory during the summer months but not at other times of the year when the household used more electricity.

When Mr Seward looked at the option of connecting to the electricity grid he found out that this would cost him and his two closest neighbours over £60,000. Wind power seemed like a viable option as Mr Seward's house is in a very windy location 480m above sea level.

A 50W wind turbine was installed to test the possibility of a larger practical turbine. The results were very encouraging, therefore after a planning application was submitted and approved a larger turbine was erected in 1993. This is situated 25m from the house and is a 2.2kW three blade machine with a 3.4m diameter, mounted on a 6.5m mast. The turbine rotor has been designed so that when the wind direction changes the rotor turns into the wind. It is connected to a generator which charges two banks of batteries. These provide the house with a 240V AC electricity supply via an inverter. When the wind speed reaches 12m/s the turbines self-regulating blades automatically sustain their power output and they also avoid being damaged by folding and twisting in high winds.

Proven Engineering is the company that manufactured the turbine and also installed it. Contact details for this company can be found in the suppliers list in appendix 6.

The cost of this small wind development was £5,000. This paid for the turbine itself, the installation costs and connection to the existing electrical circuits in the house.

Mr Seward has found this system to be of great benefit.

1. The turbine provides efficient electricity for lighting, domestic appliances and workshop tools; it also heats some of the water required for domestic heating.
2. This method of acquiring power is a cheaper and quieter option than the diesel generator which was used previously.

3. Case Study - Castalla, Spain

Self Sufficient Industrial Building for the Manufacturing of Wind Turbines

Cost of the project:	19.000.000 Pts. (114192 Euro)
Location:	Castalla (Alicante)
Supplier:	J.Bornay / Atersa
Turbines:	2
Energy produced:	4 Mwh/año
Development period	May to September 1999
Beneficiary:	Juan y David Bornay, Ltd.
Monitoring and control:	Yes
Results:	Self-sufficient manufacture.
Insurance:	Yes
Maintenance:	30.000 Pts / year (180 Euro/year)
EIA:	None
Planning permission:	None

Description

The project consisted of the electrification of all new installations of the company "Juan y David Bornay, S.R.C.", by means of a wind/solar hybrid system, composed by 2 wind turbines of 12 and 22 kW, as well as 72 solar panels. All these were aimed at charging a battery rack, which in turn feeds two inverters: a three-phase inverter of 22 KW and a mono-phase inverter of 6 kW.

In the same installation there is also a wind turbine pump that supplies water to an existing garden.

Installation

The renewable energy installation is based upon a wind/solar hybrid system. The accumulator rack is composed by 144 stationary elements 6OPZS420, which are able to store around 144 KW. This is enough to compensate for the lack of wind or solar energy for a period of 3 days.

As stated previously, the accumulator rack is fed by 72 mono-crystalline silicon solar panels placed in the front of the factory. They are connected in 3 sets of 24 panels in series in order to obtain the nominal voltage needed by the batteries. The three sets of panels are installed on a steel structure, with variable inclination so that they can capture optimal radiation depending on the season.

In the back of the plant, two wind turbines and an isolated shelter that harbours the batteries have been installed. There is also a wind turbine pump with capacity to pump water from 30 metres deep. The two wind

turbines are model Bk, one of them in the commercial version of 12 kW, and the other in an enlarged version, equipped with a three bladed rotor and automatic breaking system. Both of them are installed on independent towers of 12 and 14 m of height, tubular and four-legs, respectively.

Two converters, whose function is to transform the energy stored in the accumulators into mono-phase and three-phase energy for standard use (industrial and domestic consumption, respectively) have been installed.

4. Case Study - Castalla, Spain

Wind/solar installation for individual household supply

Cost of the project:	3.000.000 Pts (18030 Euro)
Location:	Castalla (Alicante)
Supplier:	J.Bornay/Atersa
Turbines	1
Power:	1500 W
Energy produced:	1 Mwh/ year
Development period:	September 2000
Beneficiary:	One household
Monitoring and control:	No
Results:	Individual house
Insurance:	No
Maintenance:	6.000 Pts/year (36,06 Euro/year)
EIA:	No
Planning permission:	None

Description

Electrification of an individual house using a wind/solar hybrid system, composed by one wind turbine of 1500W and 12 solar panels, both of them aimed at charging a battery rack, which in turn feeds a mono-phase inverter of 2.4 kW.

In case of emergency, a diesel generator is also available.

Installation

The installation relies upon a wind/solar hybrid system, with a stationary accumulators rack. The accumulators are composed by 12 stationary elements 60PZS600, which can store up to 20 kW; this implies self-sufficiency for a period of three days without neither sun nor wind energy.

The accumulators rack is fed by 12 mono-crystalline silicon solar panels, as well as a wind turbine, with rotors located on the top of a 12 m high tower.

In the garage of the house, a specific area has been conditioned for the storage of the batteries, the control panels, the inverter and a diesel emergency generator

GRID CONNECTED APPLICATIONS

1. Case Study - Poland, Wind Farm in Cisowo

Introduction

The wind farm is located in Cisowo, near Darlowo, in the Western Pomeranian Voivodship, which is quite close to the coast of the Baltic sea. The development is owned by a company called Energotel which is owned by Mr. Janusz from Kaminski. The farm consists of five wind turbines, 132kW each. The farm produces 1,200,000 kWh annually which covers the energy demand of around 400 households.

Environmental Benefits

The environmental benefits of this case study include the following:

- annual reduction of 1,336,000 kg of carbon dioxide
- annual reduction of 8,520 kg of sulphur dioxide
- equivalent of 432,000 kg of burnt coal reduction or 480,000 litres of crude oil
- equivalent of 185 hectares of forest area.

The wind turbines were mounted between the period of April to May 1999.

Financing

The investment into this wind farm was co-financed by the ELDORADO program - the program of the German Federal Ministry of Scientific Research. The financing of the investment was based on the principle, according to which the agreement on financial supporting of potential investments was directed to the producer of the wind turbines, in this case a company called SEEWIND. Due to the agreement, the producer was able to offer the turbines at a cost of 70% below the asking price. It was now time to see if foreign investors were willing invest.

The cost of the investment has been divided into two, the investor and the ELDORADO program.

ENERGOTEL- the company which covered 30% of the costs, paid for charges including:

- purchasing of the land,
- tests and analyses,
- documentation,
- infrastructure (low and medium voltage cables, transformer station, measurements)

The ELDORADO program covered the remaining 70% of costs which included the turbines and their transportation.

The total cost of the investment, according to the exchange rate 1DM=2.12 PLN, was equal to 1,542,500 DM. Costs incurred by the investor were equal to 588,750 DM. The cost of installation without any support from the ELDORADO program was estimated at 2330 DM/Kw. The cost of installed capacity including the support of ELDORADO was estimated at 890DM/Kw.

Obstacles to the investment realisation

The main obstacles encountered during the investment concerned mainly the human attitude towards the project. These problems appeared at the stage of local administration, which referred to the plans of investment over which there was a high level of distrust and unwillingness to co-operate. Legal regulations determining the type of investments for the project created another barrier for the developers to overcome. These are described in the local spatial development plan.

The market mechanisms, including the price of energy, made it difficult for renewable energy to be competitive against energy generated in the conventional power stations. One of the main problems was setting the price at which energy is sold to the grid. Recently, utility companies were obliged to buy the energy from renewable sources at the maximum price for the final consumer connected at low voltage. In 2001 this was changed so that the energy sales rate from renewable energy sources could be bought at the 'justified generation costs'. This new formula has potential for producers, allowing for higher energy sales rates agreed with the utility companies. The term 'justified generation costs' is not well defined, nor the procedure for deriving it given. The new regulation also sets compulsory quotas of renewable energy in the energy balance of the utility companies, rising from 2.4% in 2001 to 7.5% in 2010. It is hoped that this will improve wind turbine owners' stand point in negotiations with the utility companies.

2. Case Study - Commercial Wind Farm, Cornwall, UK

Delabole in Cornwall is an example of a commercial wind farm in the UK. A former dairy enterprise was sold at this location to form a new company called Windelectric. In 1991 the wind farm started operating under a NFFO contract.

On this site there are 10 turbines, each with a power capacity of 400KW, making a total capacity of 4MW. This was the first wind farm built in the UK. By 1997 there were 41 wind farms and the number of turbines installed at each wind farm generally exceeded 20. Turbine sizes of 500KW and 600KW were the most common.

3. Case Study - Wind Farm, Scotland, UK

Novar wind farm in Ross-Shire, Scotland was commissioned in 1997 under the Scottish Renewables Obligation (SRO) contract. This was a reasonably large project to be commissioned within the UK as there were 34 turbines of 500KW making a total capacity of 17MW for this one development.

4. Case Study - Cambridgeshire, UK

Abbey Produce (Ramsey) Ltd are potato merchants and produce handlers situated in Ramsey, Huntingdon, Cambridgeshire in an open windy fenland location. They are potato merchants and produce handlers. With a capacity of 24,000 tonnes they use around £75,000 worth of electricity a year to cool the crops.

It was decided that the wind resource in the area would be exploited by erecting a wind turbine on the company's land. Vestas supplied the wind turbine, contact details are given in appendix 6. The machine is a V27 225KW turbine, which has a 30m tower and a three bladed rotor spanning a 27m diameter. Electricity is generated at wind speeds between 5m/s and 25m/s. The rotor has a maximum rotational speed of 43rpm, with rated output reached at wind speeds of 10-12m/s. The pitch of the blades regulate the power from the turbine which itself is computer controlled.

The turbine was installed in 1993. Local Vestas also installed the transformer, switchgear and cable run to the specification of the Electricity Board. The company receives an attractive price for energy sold to the Regional Electricity Company (REC), 'Eastern Electricity'.

APPENDIX 6

Contact names & addresses

European Wind Energy Association

Rue du Trône
26 B.1040 Brussels
Belgium
Tel: +44 32 2546 1940
Fax: +44 32 2546 1944
Email: ewea@ewea.org
Internet: www.ewea.org

British Wind Energy Association

26 Spring Street
London
W2 1JA
Tel: +44 (0)207 402 7102
Fax: +44 (0)207 402 7107
Email: info@bwea.com
Internet: www.bwea.com

ETSU

New and Renewable Energy Enquiries Bureau

Harwell
Didcot
Oxfordshire
OX11 0RA
Tel: +44 (0) 1235 432450/433601
Fax: +44 (0) 1235 433066

WREAN

(Western Regional Energy Agency & Network)

1 Nugents Entry
Off Townhall Street
Enniskillen
County Fermanagh
Northern Ireland
BT74 7DF
Tel: +44 (0)28 66328269
Fax: +44 (0)28 66329771
Email: all@wrean.co.uk

Renewable Energy Office (NI)

1 Nugents Entry
Off Townhall Street
Enniskillen
County Fermanagh
Northern Ireland
BT74 7DF
Tel: +44 (0)28 66328269
Fax: +44 (0)28 66329771
Email: lisa@wrean.co.uk

Suppliers

Mr G Proven
Proven Wind Turbines
Moorfield Industrial Estate
Kilmarnock
KA2 0BA
Tel: +44 (0) 1563 543020
Fax: +44 (0) 1563 539119

Farm Power Ltd

(now Micon Turbines UK Ltd)

Unit 1
Whitebridge
Semley
Shaftesbury
Dorset
SP7 9JT
Tel: +44 (0)1747 830557
Fax: +44 (0)1747 830767

J.A. Graham

Renewable Energy Services
3 Cartnavy Road
Crumlin
Co. Antrim
BT29 4TE
Tel: +44 (0) 28 94452437
Fax: +44 (0) 28 94452437

SVIAB

Vettershaga
760 10 Bergshamra
Sweden
Phone +46 176 26 42 24
Fax: +46 176 26 42 14
e-mail: sviab@swipnet.se
Website: <http://www.sviab.com>

PitchWind

Marshultsvägen 15
510 20 Fritsla
Sweden
Tel +46 320 184 85
Fax +46 320-184 81
Mobile +46 705 26 06 04
Website: www.pitchwind.se
e-mail info@pitchwind.se
Contact person: Mr Magnus Johnsson,
managing director

ECOTECNIA

C/Amistat, 23 - 1º
08005 Barcelona
Tel: 34-93-225.76.00
Fax: 34-93-221.09.39

EMPRESA NACIONAL BAZAN S.A.

Apto. Postal 440
15480 Ferrol - La Coruña
Tel: 34-981-355 933
Fax: 34-981-354 900

Vestas Wind Systems A/S

Smed Sørensens Vej 5
DK-6950 Ringkøbing
Denmark
Tel: +45 96 75 25 75
Fax: +45 96 75 24 36
Vestas@vestas.dk
www.vestas.dk

Gamesa Eólica s.a

Poligono Comarca 1 (Agustinos)
E-31013 Pamplona
Spain
Tel: +34 9 48 30 90 10
Fax: +39 099 4 606 333

For a more extensive list of suppliers consult the EWEA web site, see contact details at the beginning of this appendix.

APPENDIX 7

Publication recommended by the European Commission

CORDIS (Community Research and Development Information Service)

'CORDIS focus' available at <http://www.cordis.lu/>

WREAN as the lead OPET in the production of this handbook, the European Commission and the other associated partners and funders do not take any responsibility for the failure of any wind projects associated with this handbook, incorrect statements made by any of the partners, misinterpretations of any of the readers or responsibility for any other error in the handbook or wind projects developed from this handbook.

© WREAN holds the copyright of this handbook. Copies should not be reproduced without the prior consent of the author. Anyone wishing to make a copy of this handbook should contact Lisa McManus at WREAN - lisa@wrean.co.uk or all@wrean.co.uk



European Commission



ENERGIE

DETI

Department of Enterprise,
Trade & Investment

*DEPARTMENT OF
AGRICULTURE AND RURAL
DEVELOPMENT*

wrean 
Western Regional Energy
Agency & Network
Assisted by ETSU